

SUSPENSIONS NÉNUPHAR

Designé par Astrid Eudeline & Ivan Grangeret

DÉTAILS DU PRODUIT

Fabrication artisanale, responsable et durable dans nos ateliers d'Anglet au Pays Basque.

MATÉRIAUX

Plafionnier

Plateau en CP Bouleau.

Globe : en verre mat

Base d'ampoule standard (E14)

Ampoule non incluse

FABRICATION À LA COMMANDE

Délai de fabrication entre 1 à 3 semaines.

DIMENSIONS

Cable textile réglable maximum 1m50

Grand Nénuphar

78 x 77 cm

Moyen Nénuphar

50 x 51 cm

Petit Nénuphar

36 x 35 cm

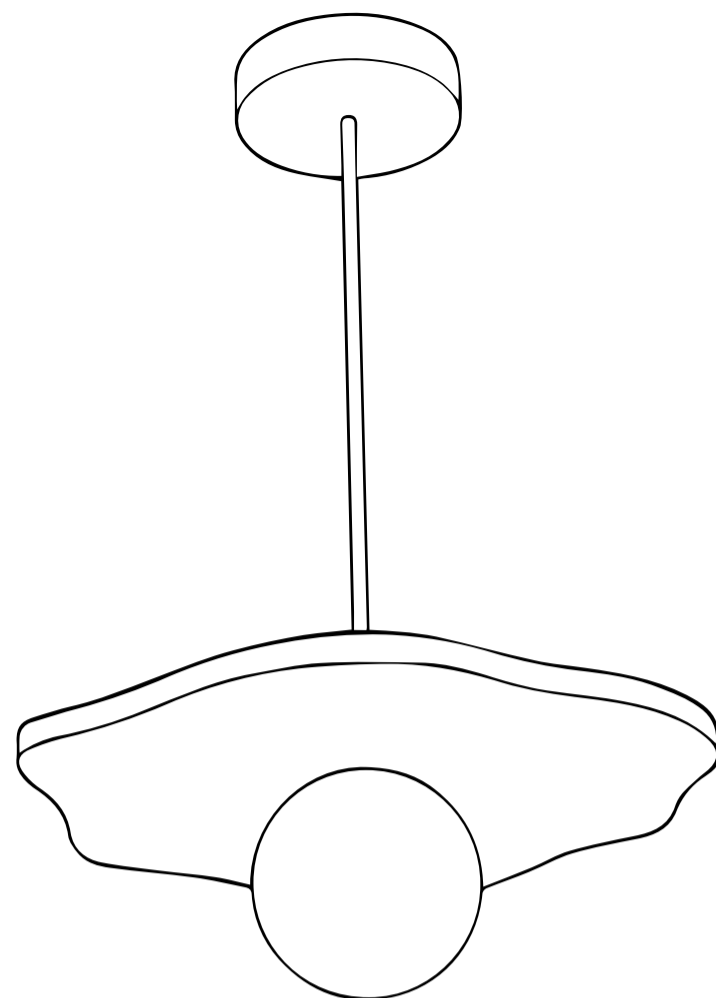

ROSACES

13 cm

13 cm

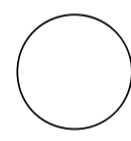
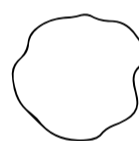

Nénuphar

Rond

TAILLES DES PLAFONNIERS

Grand Nénuphar

Moyen Nénuphar

Petit Nénuphar

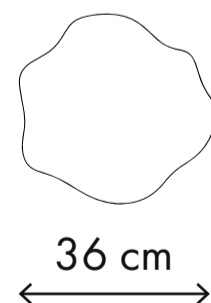
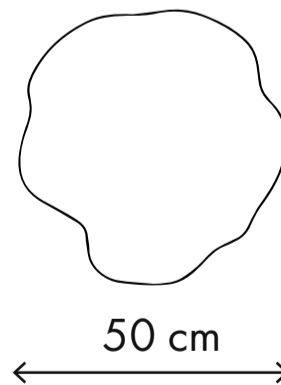
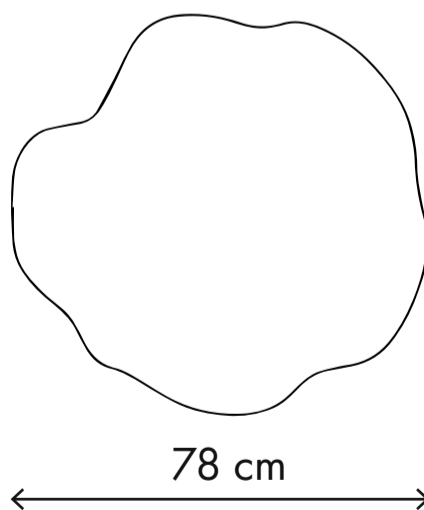

TAILLES DES GLOBES

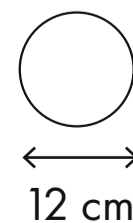
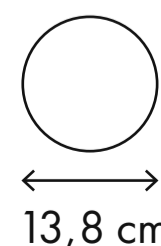
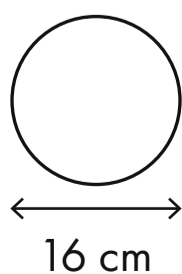

PLAN DE L'OBJET

